



Performance through thick and thin

Alfa Laval Compabloc welded heat exchangers



- Maximum reliability – limit your risks
- Save energy
- Reduce maintenance costs
- Increase production
- Cut capital costs



Performance through thick and thin

With over 25,000 units handling tough duties for companies worldwide, Alfa Laval's Compabloc welded heat exchanger is a proven product with a reputation for reliability and efficiency.

Compablocs are used in a wide range of applications and are specially developed for operating with aggressive media, high temperatures and pressures.

They are the perfect choice for reboiler, condenser and liquid-to-liquid heat exchanger duties in chemical, petrochemical and refinery plants.

Maximum reliability.

Maximum performance

Compabloc combines the temperature and pressure durability of a shell-and-tube heat exchanger with the exceptional thermal efficiency of a traditional plate heat exchanger.

Depending on the application, a Compabloc is up to 5 times more efficient than a comparable shell-and-tube and offers maximum reliability. It needs less maintenance, which can be performed quicker. Compabloc gives you the possibility to lower operating costs, increase production, and reduce capital costs.

Custom built because every process is different

Every process plant is unique. Each Compabloc is custom built and configured to meet the specific conditions they will operate under. The result is optimum performance and minimum down-time.

Unrivalled expertise and experience – close to you

Alfa Laval offers superior products combined with deep application knowledge and long industry experience. Our highly skilled engineers support you in every step from product choice, design and commissioning to continuous optimized operation and service.

Our global service organization combines the advantages of a worldwide network of field service engineers, service centres and parts warehouses with a commitment to individualized service, local presence and strong partnerships with our clients.

It's Alfa Laval's rich vein of experience that makes the difference to your business. As experts in heat transfer technology, we know your industry inside-out. We have the technical know-how to deliver solutions that increase profitability and reliability. Expertise you can rely on – every time.



CASE STORY

Compabloc condensers – going well at Shell

Shell recovered an additional 13.5 MW of heat at its refinery in Sarnia, Canada after replacing the existing shell-and-tube condensers with eight Compablocs. All previous corrosion problems were eliminated since the Compablocs were made of Hastelloy C276®.



Benefits you can rely on

You know it works

People choose Alfa Laval Compablocs for one simple reason. They just work. Our proven manufacturing and technical solutions lead to high reliability and a long working life. Many Compablocs that have been in continuous operation for decades are still delivering peak performance.

Save energy and reduce CO₂

The high thermal efficiency leads to lower boiler fuel consumption and reduced CO₂ emissions when Compablocs are used for heat recovery.

Reduce maintenance costs and boost performance

A Compabloc offers minimum fouling, allowing it to operate with cleaning intervals substantially longer than traditional heat exchangers. It is the only welded heat exchanger where all channels, both hot and cold, can be fully cleaned using a hydrojet, bringing performance back to 100% after cleaning.

Increase production and slash installation costs

Bottlenecks related to heating or cooling can often be resolved with more efficient heat exchangers. The compact size of a Compabloc enables you to pack more performance into the same space, or free up space for other types of equipment. It also means lower heat exchanger and installation costs.

Payback in months

High energy efficiency combined with low installation and maintenance costs means Compablocs offer much shorter payback times than other technologies, such as shell-and-tube or other types of plate-and-block heat exchangers. Equipment often pays for itself in a matter of months.

Compabloc is available in a wide range of sizes and is custom made to fit the specific operating and installation conditions. It can be made in virtually any material that can be pressed and welded.

- Superior heat transfer and minimal fouling
- Asymmetric flows
- Crossing temperatures in a single unit
- Fully mechanically cleanable
- Laser-welded plates
- No corrosion issues

The champion of heat exchange

Sitting at the core of every Compabloc is a stack of corrugated heat-transfer plates made of stainless steel or other corrosion-resistant materials, laser welded alternately to form channels. The all-welded design makes gaskets between plates a thing of the past.

The hot and the cold streams flow through alternate channels. Corrugated plates cause high turbulence, resulting in substantially higher heat transfer efficiency compared to shell-and-tube heat exchangers. This means a Compabloc operates with a 50–80% smaller heat transfer area.

Flow turbulence also causes high shear stress along the plates, reducing the build-up of fouling.

Flow paths for peak performance

The two flows in a Compabloc can be configured as either single or multiple pass by using baffles. The number of passes on the hot and cold side can be chosen independently, making it possible to optimize heat transfer even if flow rates on the different sides differ greatly.

The baffles are made to withstand full vacuum, and can be rearranged if design conditions are changed in the future.

Crossing temperatures reduces energy bills

The overall flow in a Compabloc is counter-current, and it can operate with a crossing temperature program (in a single unit) where the temperature approach is as close as 3°C (5.4°F), maximizing energy recovery.

Installed wherever you need them

The small size and light weight makes it possible to install Compablocs anywhere, for instance at the top of distillation columns or suspended from support structures.

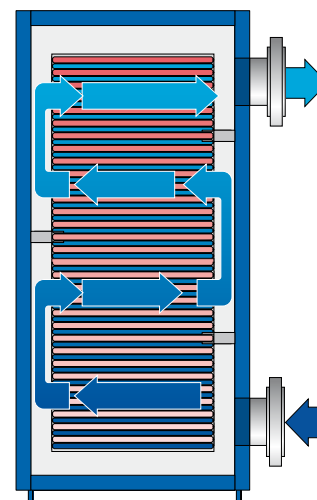
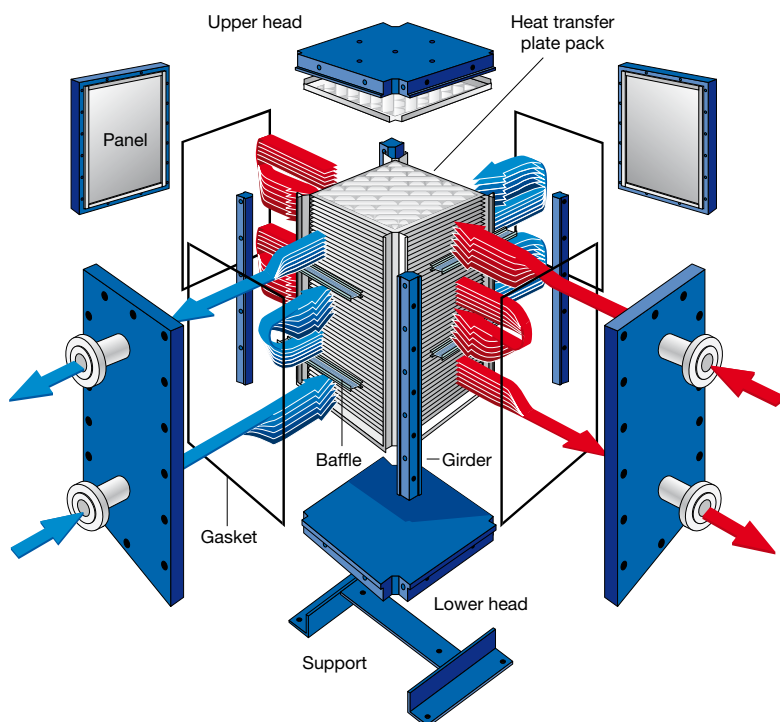

The flow is directed using baffles. The numbers of passes on the hot and cold side are individually chosen to maximize heat transfer and minimize fouling.

Compabloc helps Russian Sayanchimplast make big savings

Sayanchimplast wanted to increase efficiency in their vinyl chloride monomer (VCM) production plant by reusing the heat from a process stream in a reboiler. Their plan was almost thwarted when the shell-and-tube they chose for this duty clogged repeatedly. By replacing it with a low-fouling Compabloc, they eliminated clogging and saved EUR 240,000 per year in steam costs. With Alfa Laval they experienced no more tar deposits, excellent thermal efficiency and absolute reliability.

Install a Compabloc vertically, horizontally or suspended, depending on the duty and available space. Alfa Laval assists with installation guidance.

The required service area of a Compabloc is also much smaller than traditional technologies. It's easy to access all welds and channels for servicing by simply removing the side panels.

Tough equipment for tough duties

The all-welded design allows Compablocs to handle aggressive media with ease and reliability, and operate at high pressures and temperatures.

The unique plate-to-plate joint design means there are no dead zones where fouling deposits can collect, or where

they cannot be cleaned, and there are no crevices to act as sites for corrosion initiation.

Laser-welded plates for greater reliability

Laser welding creates a thinner, more accurate weld compared to traditional TIG welding, significantly reducing heat input and making the welds more resistant to fatigue and pressure peaks.

The joints between the plates are butt welded, eliminating the risk of crevice corrosion common to other welded heat exchangers. The butt-welded design also reduces stress on the welds from thermal expansion. All the welds in a Compabloc are fully accessible.

The result is a unit that is less susceptible to stress, fatigue and crevice corrosion, improving reliability, extending its working life and making it highly resistant in harsh environments.

The corrosion beater

The small heat transfer area makes it economically feasible to use highly corrosion resistant materials. This leads to higher reliability, fewer unplanned stops, fewer inspections and reduced downtime for repairs.

Compabloc is available in virtually any material that can be pressed and welded, for example: AISI 304L, Alloy C22, AISI 316L, Alloy C276, Alloy B-2, Titanium, Tantalum, Titanium-palladium, Incoloy™ 825, 254 SMO, Hastelloy™ C2000, 904L (UB6)

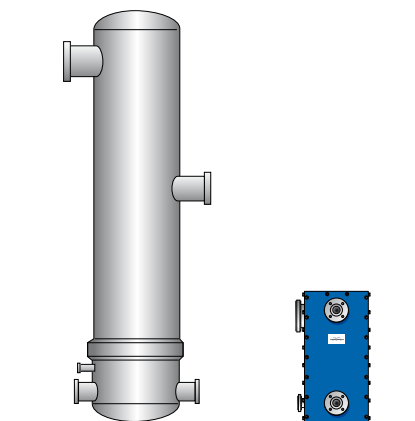

Superior heat transfer means a Compabloc is much smaller and lighter than a comparable shell-and-tube heat exchanger. The required installation space is minimal since no tube bundle needs to be extracted.

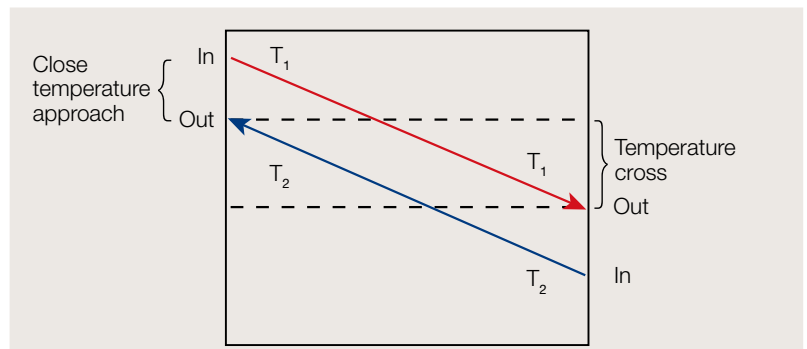

The counter-current flow in Compabloc allows you to have crossing temperatures within a single heat exchanger. The temperature approach can be as close as 3°C (5.4°F).

The perfect process heat exchanger

The Compabloc is versatile, resilient and extremely reliable. It performs excellently for a large range of challenging duties. The flexible pass arrangements and its high heat transfer efficiency makes Compabloc ideal for tough liquid-to-liquid duties with dissimilar flow rates, as well as in condensation and reboiler positions.

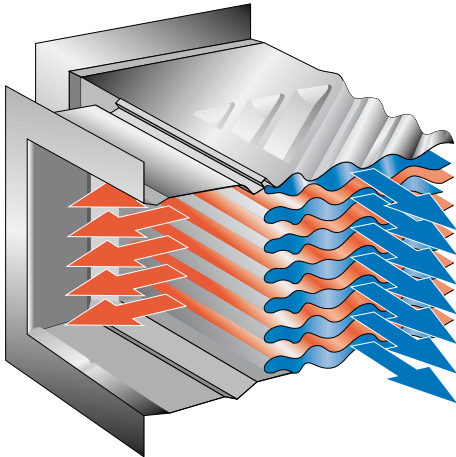
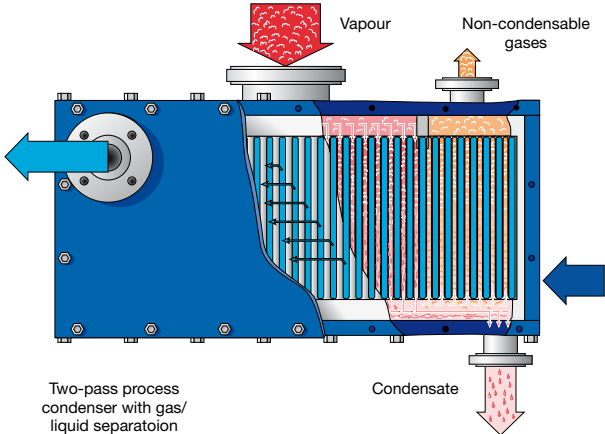
Liquid-to-liquid	Condenser
	 <p>Two-pass process condenser with gas/liquid separation</p>
<p>In full flow with liquid-to-liquid heating/cooling</p>	<p>Taking the pressure out of condensing duties</p>
<p>Performing at 3-5 times the efficiency of shell-and-tubes, Compabloc is perfectly placed as a liquid-to-liquid heat exchanger (heater, cooler or interchanger). Its ability to handle crossing temperatures in a single unit, and with a temperature approach as close as 3°C (5.4°F), Compabloc offers significant energy-saving possibilities.</p> <p>Compabloc handles asymmetric flows with ease thanks to its flexible flow configuration. Since you can install this lightweight unit horizontally or vertically, installation problems are instantly solved.</p> <p>Benefits</p> <ul style="list-style-type: none"> • Crossing temperatures in a single unit • Close temperature approach, 3°C (5.4°F) • Handles asymmetric flows • Energy savings due to high heat recovery • Compact • Flexible installation • Minimal fouling • Easy access to all welds and channels 	<p>The high flow turbulence, short flow path and large cross-flow area gives Compabloc a low pressure drop and high efficiency, making it ideal for condensing duties.</p> <p>High turbulence maximizes cooling and prevents the build-up of fouling, making Compabloc the best choice for long-term efficiency and consistent performance. As a result, Compabloc performs condensing duties 2-4 times more efficiently than traditional solutions. Vapour enters from the top of the unit and condenses on the cold plates as it passes through the plate pack, with condensate exiting at the bottom.</p> <p>If the vapour contains non-condensable gases, Alfa Laval can design a two-pass arrangement on the condensing side that permits gas/liquid separation inside Compabloc, eliminating any need for a separator unit. Main condensation takes place in the first pass. Subcooling of non-condensable gases is achieved in the second pass, which also serves as a mist eliminator.</p> <p>Benefits</p> <ul style="list-style-type: none"> • Low pressure drop and effective cooling • Tailor-made for each specific duty (full or partial condensation, subcooling of inerts and/or condensate) • Minimal cooling water fouling • Gas-liquid separation possible directly in Compabloc

Reboiler

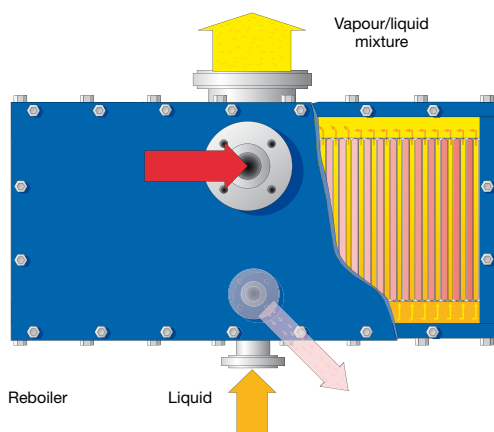

Fast facts

Design temperature	400°C (752°F), down to -100°C (-148°F)
Design pressure	From full vacuum to 42 barg (600 psig)
Maximum heat transfer area	840 m ² (8,985 ft ²)
Maximum liquid flow rate per unit	6,000 m ³ /h (26,250 US gpm)
Lowest achievable temperature difference	3°C (5.4°F)
Duties	Heat recovery, cooling, heating, condensation, partial condensation, reboiling, evaporation and gas cooling.
Performance	Low to high thermal length or NTU duty. Handles any corrosive medium.

Cooking up great results as a reboiler

High thermal efficiency, compact size, low static head, minimum fouling and easy cleaning make Compabloc the perfect reboiler. It can be used as a thermosiphon or forced circulation reboiler. Compabloc makes it easy to increase reboiler capacity, offering up to double the capacity of a traditional heat exchanger of the same size.

The compact size means the hold-up volume is very low compared to a traditional heat exchanger. This makes starting the process quicker and the cost for the out-of-spec process fluid lower.

Benefits

- High efficiency
- Minimal fouling
- Easy cleaning
- Low hold-up volume – quick process start and lower investment costs
- Low static height required

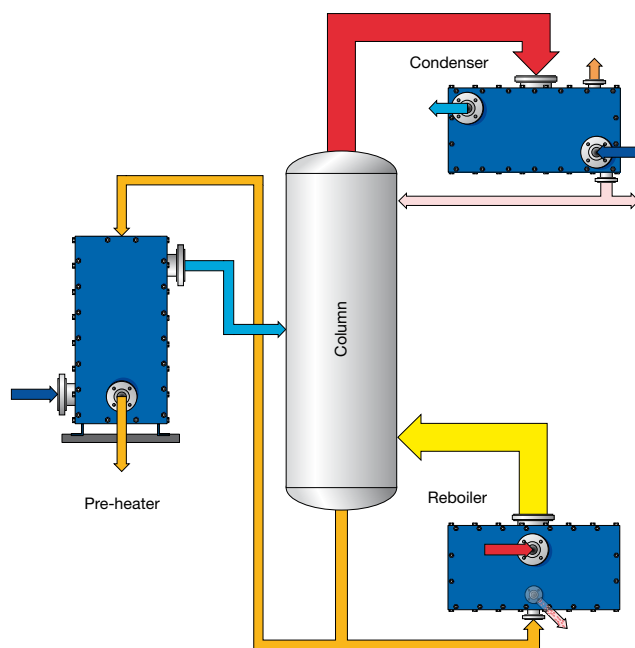

Compablocs are the perfect choice for reboiler, condenser and liquid-to-liquid heat exchanger duties.



CASE STORY

Vastly improved heat recovery at petrochemical plant in Asia

Compabloc heat exchangers have enabled a petrochemical company in Asia to increase capacity for the production of benzene and toluene, while improving heat recovery levels.

Compablocs offer highly competitive capital and installation costs, more capacity, and use less space than the original installation. They also feature long service intervals, easy service access, high heat recovery and lower emissions, making the choice easy.

Offering you the best

Alfa Laval equipment serves some of the most challenging industries in the world, delivering exceptional reliability and efficiency.

It's not just our durable equipment you can rely on to do the toughest jobs. Alfa Laval is a global organization with unrivalled expertise and experience in welded heat exchangers. For more than 25 years we have

helped industries convert to modern heat exchanger technology and increase their profitability.

We are with you every step of the way. Our experienced engineers custom design your Compabloc to meet your exact needs. We make sure you get top performance, even in complicated applications such as reboiling and condensation.

Thanks to our long experience from across the globe we have references from most applications in the hydrocarbon industry.

We can help you with commissioning, maintenance and repairs through our worldwide service organization.

Petrochemicals

Alfa Laval Compabloc heat exchangers provide cost-efficient energy recovery, improved heating, cooling, condensing and evaporation in many different petrochemical applications. Compablocs are installed in production plants for ethylene, aromatics, isocyanates and many other processes. Every day, Compablocs deliver increased profitability and reduced costs, floor space and emissions in plants across the world.

Fouling in the petrochemical industry is a challenge Compabloc meets head on. The highly turbulent flow minimizes fouling and maintenance downtime. However, process upsets can happen. In such cases Compablocs are easily cleaned and your plant is back at full capacity again in the fastest possible time.

Flexible, compact and powerful, Alfa Laval can adapt the Compabloc to fit any application where high performance is required. The high

thermal efficiency makes Compabloc the perfect choice for heat recovery and can substantially reduce your energy costs.

We have over 12,000 Compablocs in continuous operation serving clients in the petrochemical industry with outstanding results. Equipment you can rely on, time and time again.

How a Brazilian ethylene plant got more for their money

Braskem, a top Brazilian petrochemical company, challenged Alfa Laval's engineers to come up with a reliable and compact solution for quench water cooling in an ethylene plant they were planning to revamp, and got more benefits than it bargained for.

The company installed two stainless steel Compabloc heat exchangers, especially



adapted for their process. The smaller size of the Compablocs meant they easily fitted into the available space.

The company experienced a dramatic cut in fouling and corrosion compared to existing shell-and-tubes, and after five years they hadn't had to clean the units once.

Energy savings	2,100 kW
Fuel savings/year	2,028 tons
Fuel cost savings/year	USD 446,000
CO ₂ -emission savings/year	5,280 tons
CO ₂ -emission cost savings/year	USD 104,000
Annual cost savings	USD 550,000

Disclaimer: Price of natural gas: USD 220/ton / Heat of combustion of natural gas: 48 MJ/kg / CO₂-emission cost: USD 20/ton / CO₂-emission: 2.6 ton/ton natural gas / Operation time/year: 350 days / Boiler efficiency: 65%

Refineries



Alfa Laval heat exchangers are designed for total reliability in the toughest environments. There are more than 1,500 Alfa Laval Compabloc heat exchangers serving crude oil refineries worldwide, in all major processes: crude preheating in atmospheric distillation columns, vacuum distillation, hydrocrackers, FCCs, desalters, amines and many more.

In crude oil refineries uptime is money and reliability is key, so equipment must be durable, robust and highly corrosion-resistant. Despite the aggressive media and high risk of fouling, Compabloc heat exchangers keep your refinery operating at optimum level with no unscheduled downtime.

Compablocs improve performance and eliminate corrosion at Brazilian crude oil refinery

In 2002, Petrobras Replan oil refinery began replacing some of its shell-and-tube condensers with Compabloc compact heat exchangers. The switch to compact heat exchangers was prompted by corrosion problems in the

shell-and-tube condenser in the sour water stripping column, and the need to improve the thermal performance of the condensers in the fluid catalytic cracking unit, FCC.

The switch eliminated all corrosion problems in the sour water stripping column condenser. In the FCC unit, the new condensers provide 20% additional heat transfer capacity in a much smaller space. The improved cooling made it possible to reduce the hydrocarbon load on the compressors.

Today, Petrobras has more than 60 Alfa Laval Compabloc heat exchangers installed in its refineries in Brazil.

Chemicals

Compablocs are used in a number of processes in the chemical industry, like production of coke oven gas and fertilizers. In fertilizer production, highly aggressive media and high temperatures cause corrosion and costly unscheduled downtime. By installing Alfa Laval Compabloc heat exchangers as heaters, coolers, condensers, evaporators and reboilers, more than 50 companies have increased plant efficiency in the last few years and are enjoying huge savings.

Compabloc is highly corrosion resistant and designed to minimize fouling. It makes unscheduled downtime a thing of the past and slashes maintenance costs. Its counter-current flow makes it possible to work with temperature approaches as small as 3°C (5.4°F) – offering outstanding thermal efficiency. And its compact design means lower

investment and installation costs, freed-up floor space and considerable energy savings. All in all, technology you can rely on.

Saving energy in a Slovakian ammonium nitrate plant

When building their evaporation system, the key challenge for a Slovakian ammonium nitrate plant was to find robust equipment that would offer them maximum thermal efficiency and guarantee low energy consumption.

The company installed two Compablocs serving as interchangers before the second effect evaporator. The equipment handles aggressive media with ease, and the increased preheating of incoming ammonium nitrate saves 5 MW of energy. Apart from reducing steam consumption, the Compabloc solution uses much less space than



bulky shell-and-tubes would require. Corrosion-resistant materials are costly, and the compact size meant the cost of the heat exchanger was very small compared to a shell-and-tube solution.



Making maintenance simple and efficient

Quick and straightforward service characterizes Compabloc. In most cases all services are performed on a Compabloc without moving the heat exchanger.

If you need to inspect, clean or repair a Compabloc, all welds and channels are accessed by simply opening the side panels.

Minimum fouling and easy to clean

We tailor each Compabloc to its operating conditions, and ensure fouling is minimized by optimizing turbulence. Our deep process knowledge and long experience makes sure you get the best performance and minimum maintenance costs.

The channels in a Compabloc are fully cleanable, either mechanically using a water jet, or chemically by circulating special detergents with an Alfa Laval CIP (Cleaning-In-Place) unit. Either of

these methods is usually all it takes to get a Compabloc back up to 100% performance. Compare this to all other versions of plate-and-block exchangers where dead zones mean 100% recovery is never achievable.

Sooner or later all plants experience unplanned shutdowns. Using easy-to-clean Compablocs means you can quickly bring your operations back to full capacity.

By analysing fouling samples we can advise you on the optimum combination of chemicals, concentrations and temperature for chemical cleaning.

Service in the spotlight

By selecting Alfa Laval equipment, you choose unmatched reliability, optimal performance and availability. We give you total peace of mind for the entire lifetime of your equipment.

On time, all the time

When uptime is money, reliability and availability are everything. You can count on Alfa Laval for timeliness – be it prompt onsite assistance from our skilled service engineers, spare parts deliveries, or specialized services from one of our service centres.

As an Alfa Laval customer you have access to a world-class service organization. We have a strong local presence in most industrial areas of the world, and our team of field service engineers and welding specialists are ready to assist you in your local language.

Service centres

Alfa Laval's worldwide network of service centres are on stand-by in the unlikely event of more serious issues with Alfa Laval equipment. Our highly trained product specialists will help return any damaged unit to full operation in the shortest possible time. The Compabloc Full Inspection service, available at all our welded service centres means your Compabloc is checked in detail, cleaned, and if needed repaired, before it is returned to you.

We are here to help

In case you need assistance our local field service engineers are ready to help you with on-site cleaning and repairs at short notice, getting your process up and running as quickly as possible. Installation and commissioning support ensures trouble-free start-up and helps you get the most from your Compabloc in terms of performance and reliability. We also offer training for operators and maintenance personnel.



CASE STORY

Compabloc saves on maintenance costs

The Kakogawa coke plant in Japan cut both investment and maintenance costs when replacing four shell-and-tubes with four Compablocs. The shell-and-tubes required cleaning twice a year. Two years after installation, two of the Compablocs had not required any service at all and were still operating without problems.



About Alfa Laval

Alfa Laval is a leading global provider of specialized products and engineered solutions.

Our equipment, systems and services are dedicated to helping customers to optimize the performance of their processes. Time and time again.

We help our customers to heat, cool, separate and transport products such as oil, water, chemicals, beverages, foodstuff, starch and pharmaceuticals.

Our worldwide organization works closely with customers in almost 100 countries to help them stay ahead.

How to contact Alfa Laval

You can always find up-to-date Alfa Laval contact details for all countries on our website at www.alfalaval.com

